

GORDON[®]
 ARCHITECTURAL+ENGINEERED SOLUTIONS

5023 Hazel Jones Rd.
 Bossier City, LA 71111
 800.747.8954
 GORDON-INC.COM
 sales@gordon-inc.com

SECURITY CEILINGS
 TAMPER-EVIDENT - LOCKDOWN
 ISOMETRIC ASSEMBLY

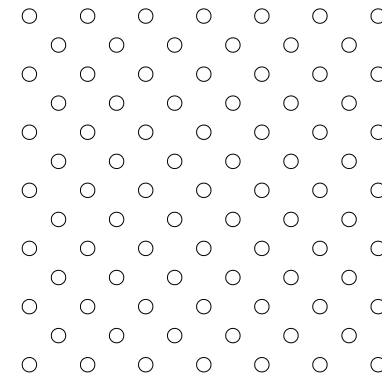
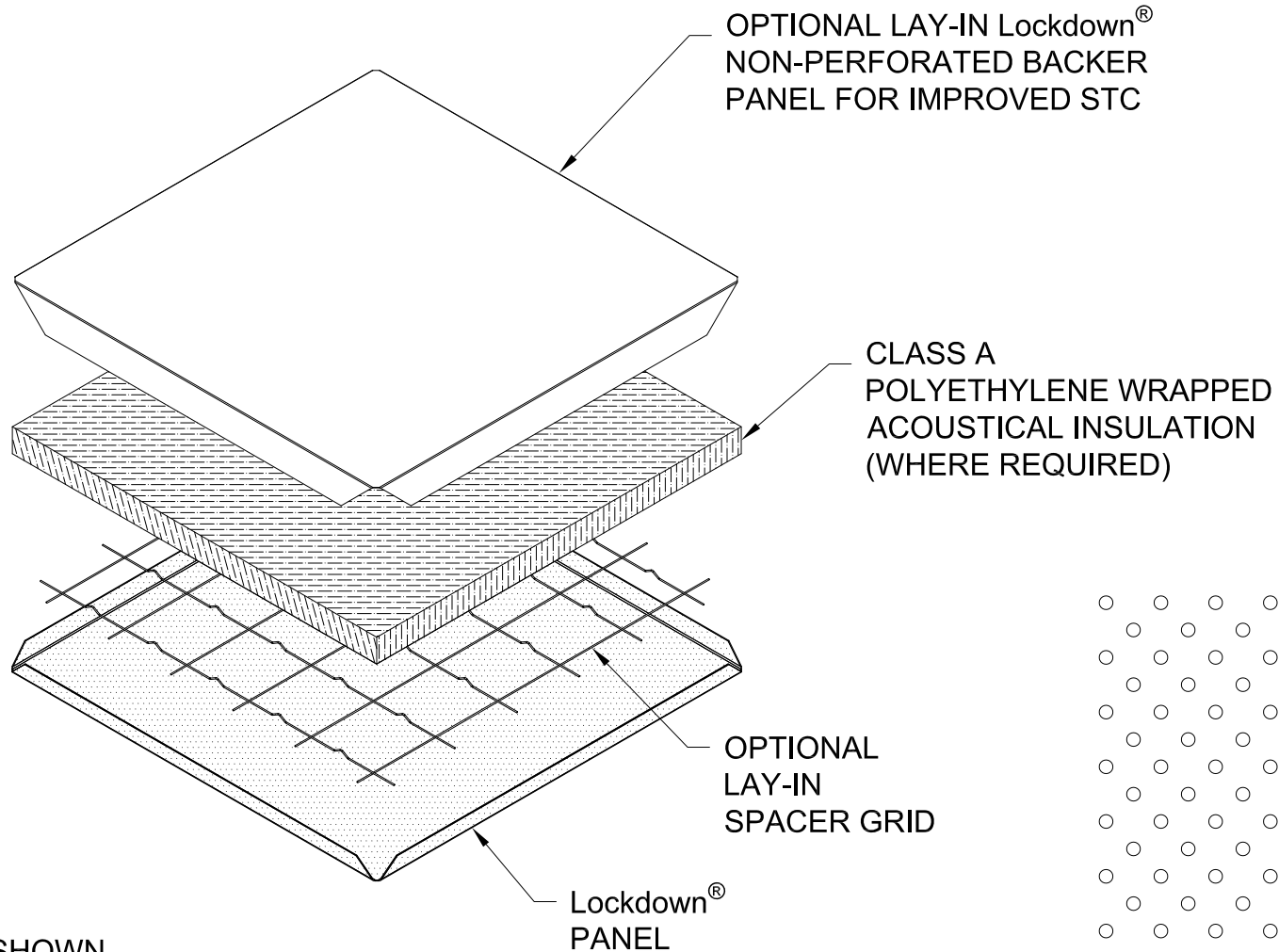

R564-732DG10 PANEL PERFORATION DETAIL
5/64" HOLES ON 7/32" 45° DIAGONAL CENTERS
10% OPEN AREA

2' X 2' SHOWN
 2' X 4' ALSO AVAILABLE

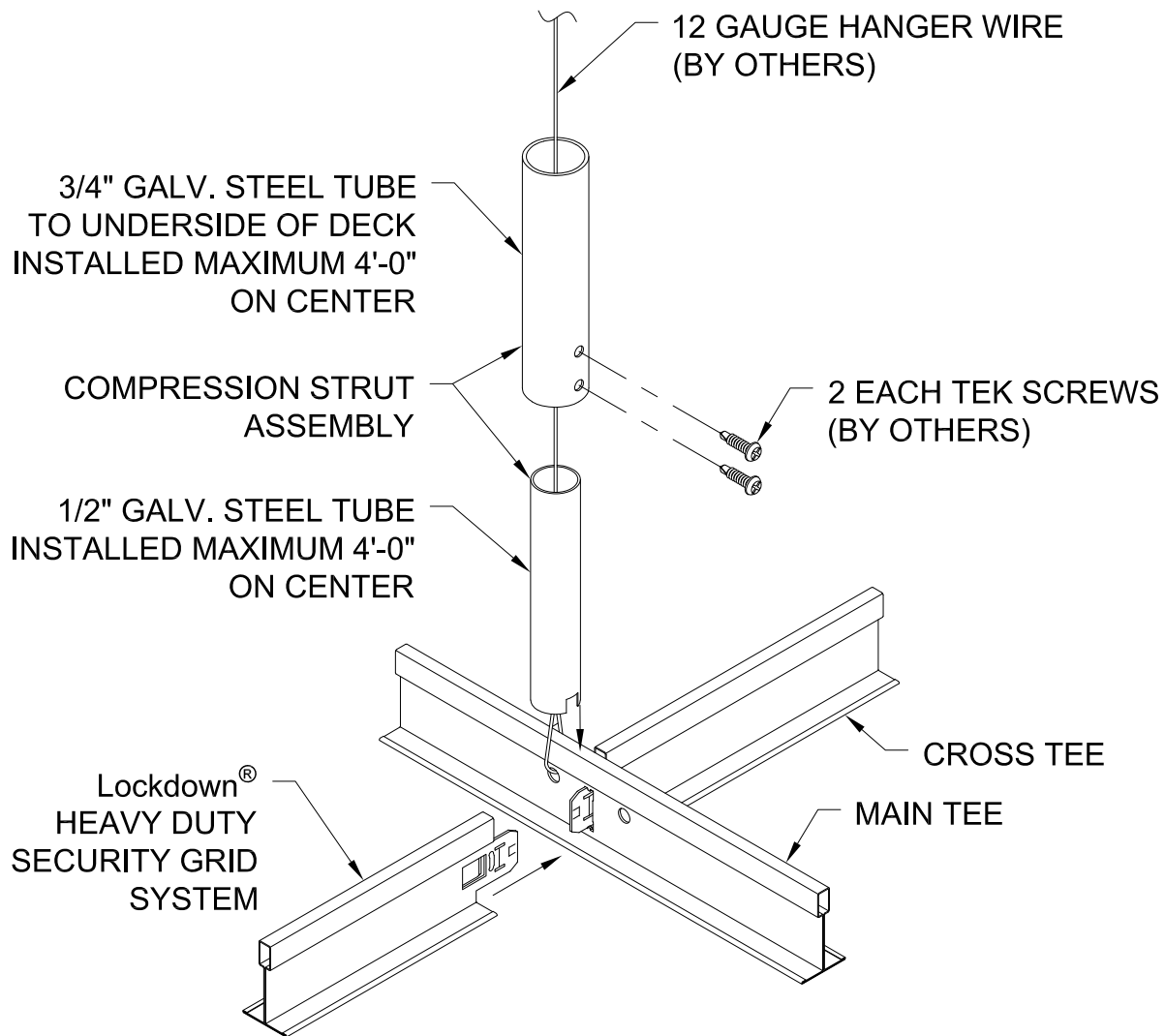

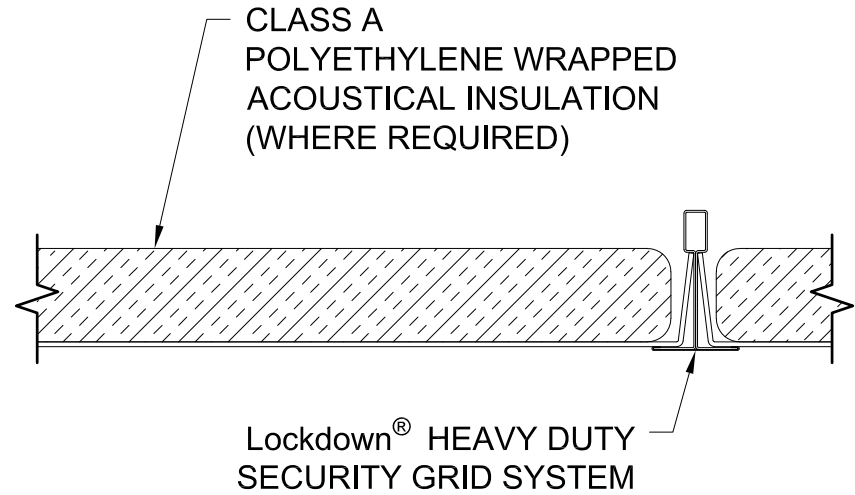
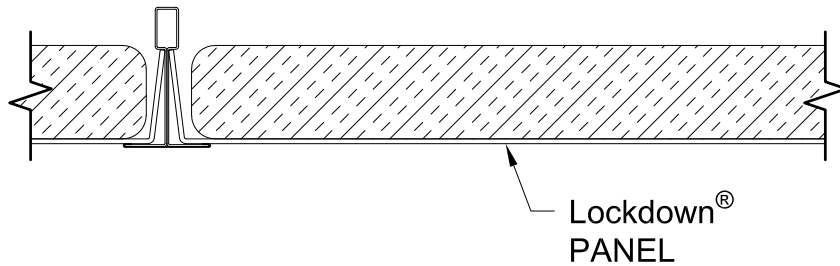

GORDON[®]
ARCHITECTURAL+ENGINEERED SOLUTIONS

5023 Hazel Jones Rd.
Bossier City, LA 71111
800.747.8954
GORDON-INC.COM
sales@gordon-inc.com

SECURITY CEILINGS
TAMPER-EVIDENT - LOCKDOWN
TYPICAL PANEL SECTION

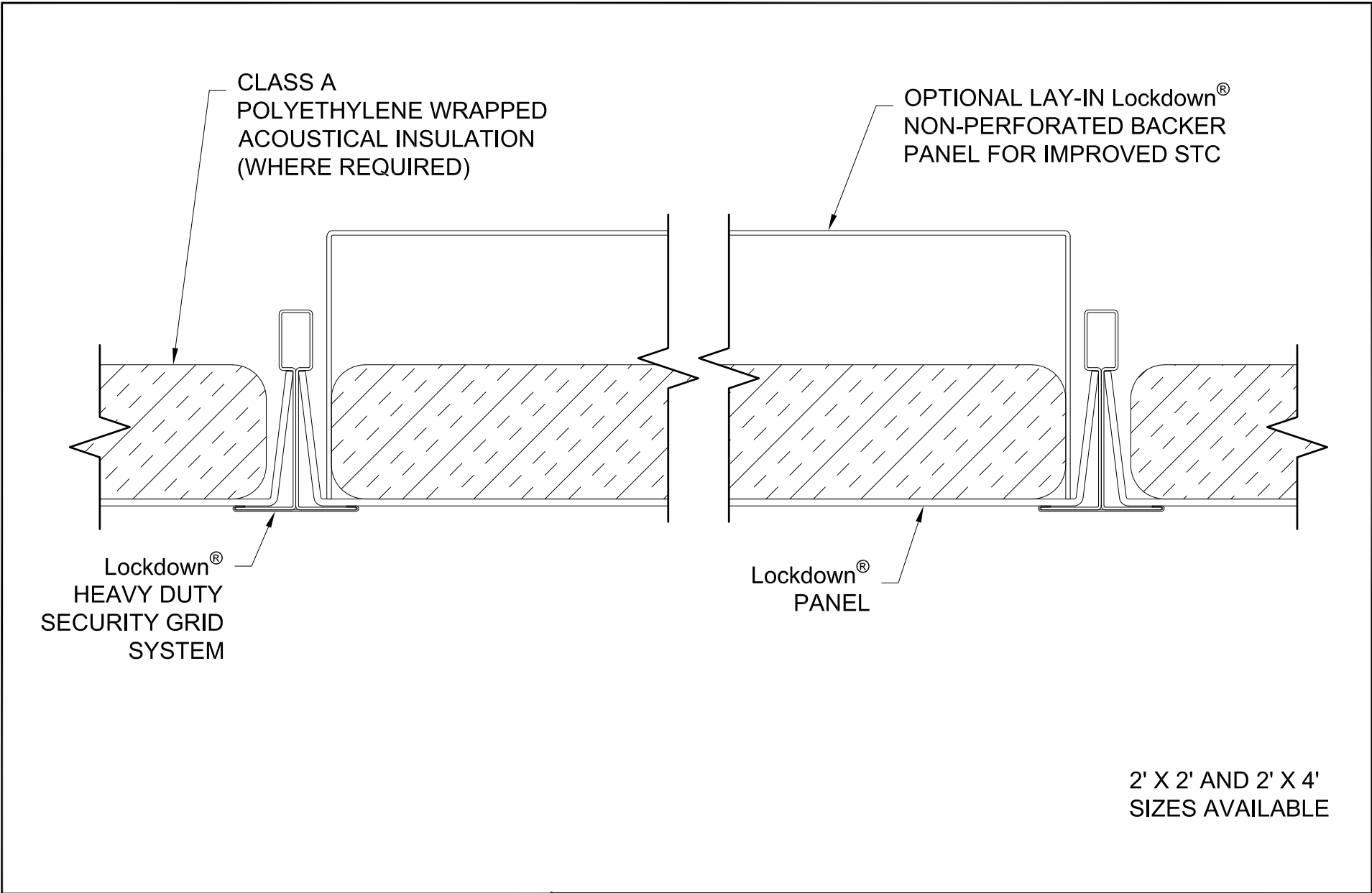

GORDON®
ARCHITECTURAL+ENGINEERED SOLUTIONS

5023 Hazel Jones Rd.
Bossier City, LA 71111
800.747.8954
GORDON-INC.COM
sales@gordon-inc.com

**SECURITY CEILINGS
TAMPER-EVIDENT - LOCKDOWN
BACKER PANEL SECTION**

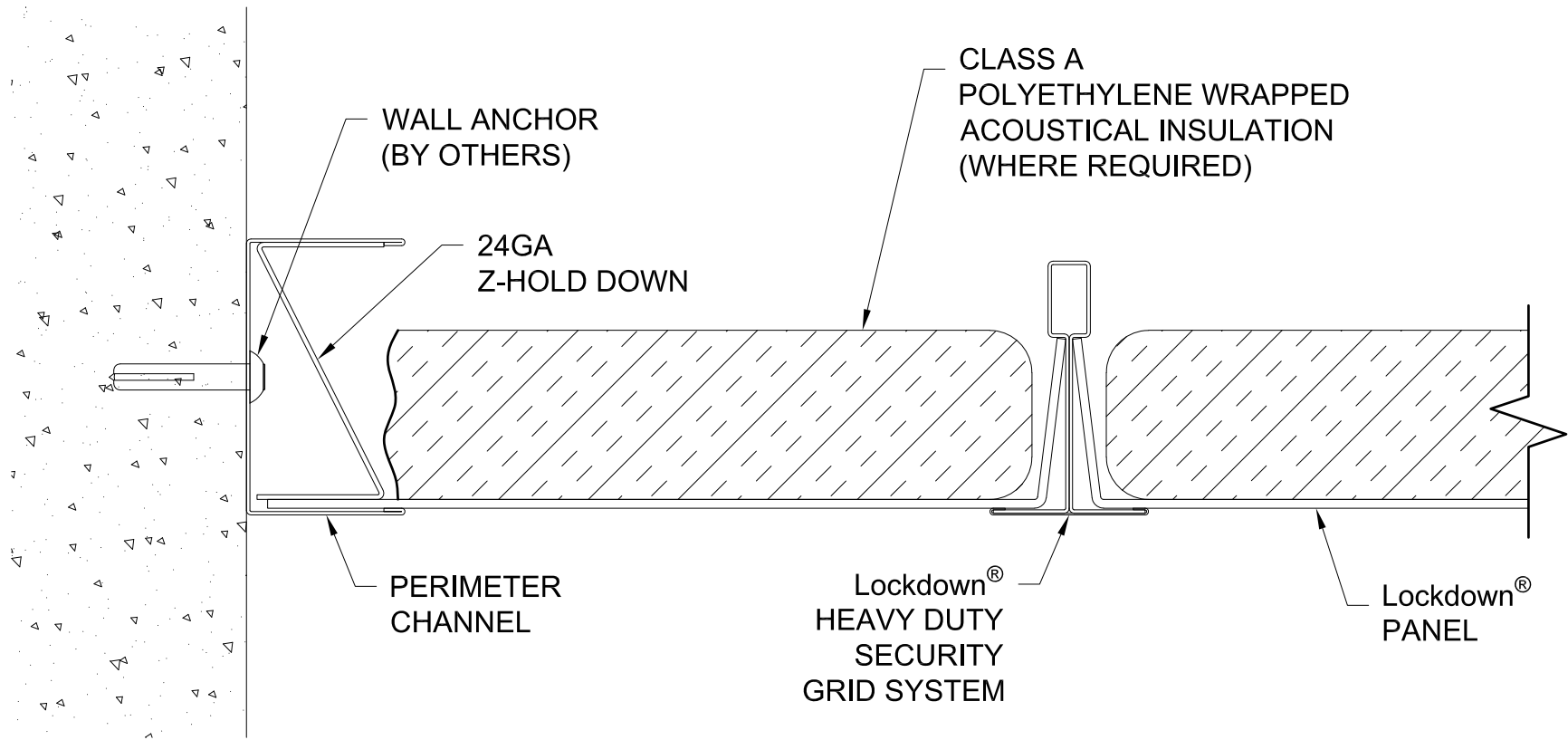

GORDON®
ARCHITECTURAL+ENGINEERED SOLUTIONS

5023 Hazel Jones Rd.
Bossier City, LA 71111
800.747.8954
GORDON-INC.COM
sales@gordon-inc.com

SECURITY CEILINGS
TAMPER-EVIDENT - LOCKDOWN
PERIMETER SECTION

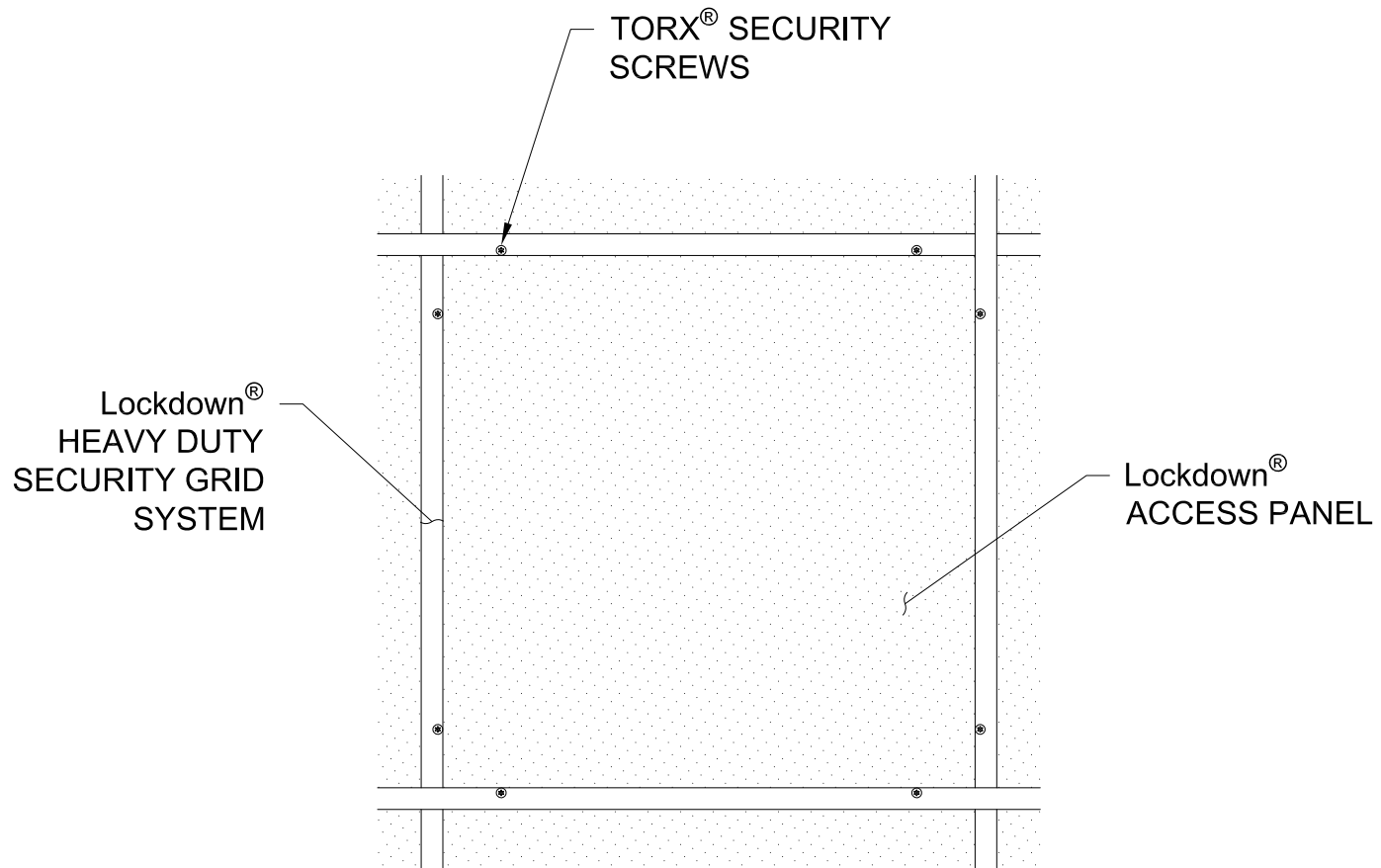

TORX[®] IS A REGISTERED TRADEMARK OF CAMCAR

2' X 2' SHOWN
2' X 4' ALSO AVAILABLE

GORDON[®]
ARCHITECTURAL+ENGINEERED SOLUTIONS

5023 Hazel Jones Rd.
Bossier City, LA 71111
800.747.8954
GORDON-INC.COM
sales@gordon-inc.com

SECURITY CEILINGS
TAMPER-EVIDENT - LOCKDOWN
ACCESS PANEL - FACE VIEW

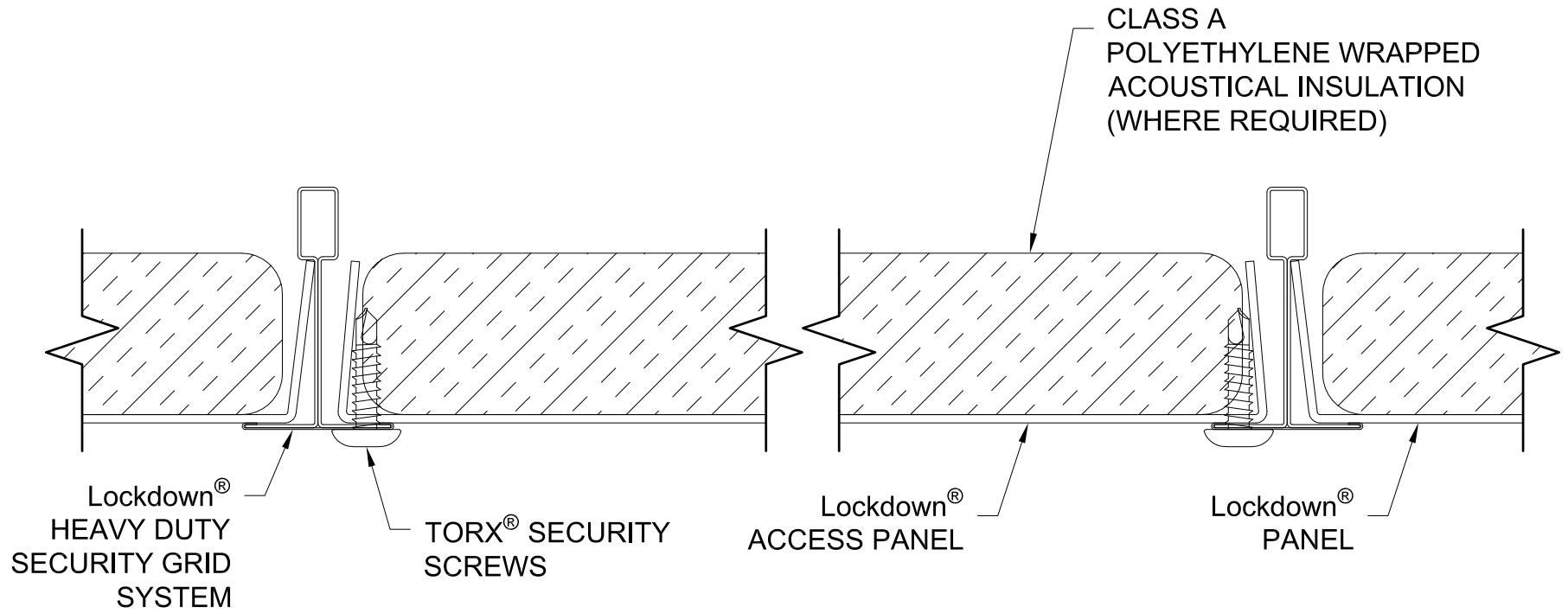

TORX® IS A REGISTERED
TRADEMARK OF CAMCAR

2' X 2' AND 2' X 4'
SIZES AVAILABLE

GORDON®
ARCHITECTURAL+ENGINEERED SOLUTIONS

5023 Hazel Jones Rd.
Bossier City, LA 71111
800.747.8954
GORDON-INC.COM
sales@gordon-inc.com

SECURITY CEILINGS
TAMPER-EVIDENT - LOCKDOWN
ACCESS PANEL SECTION

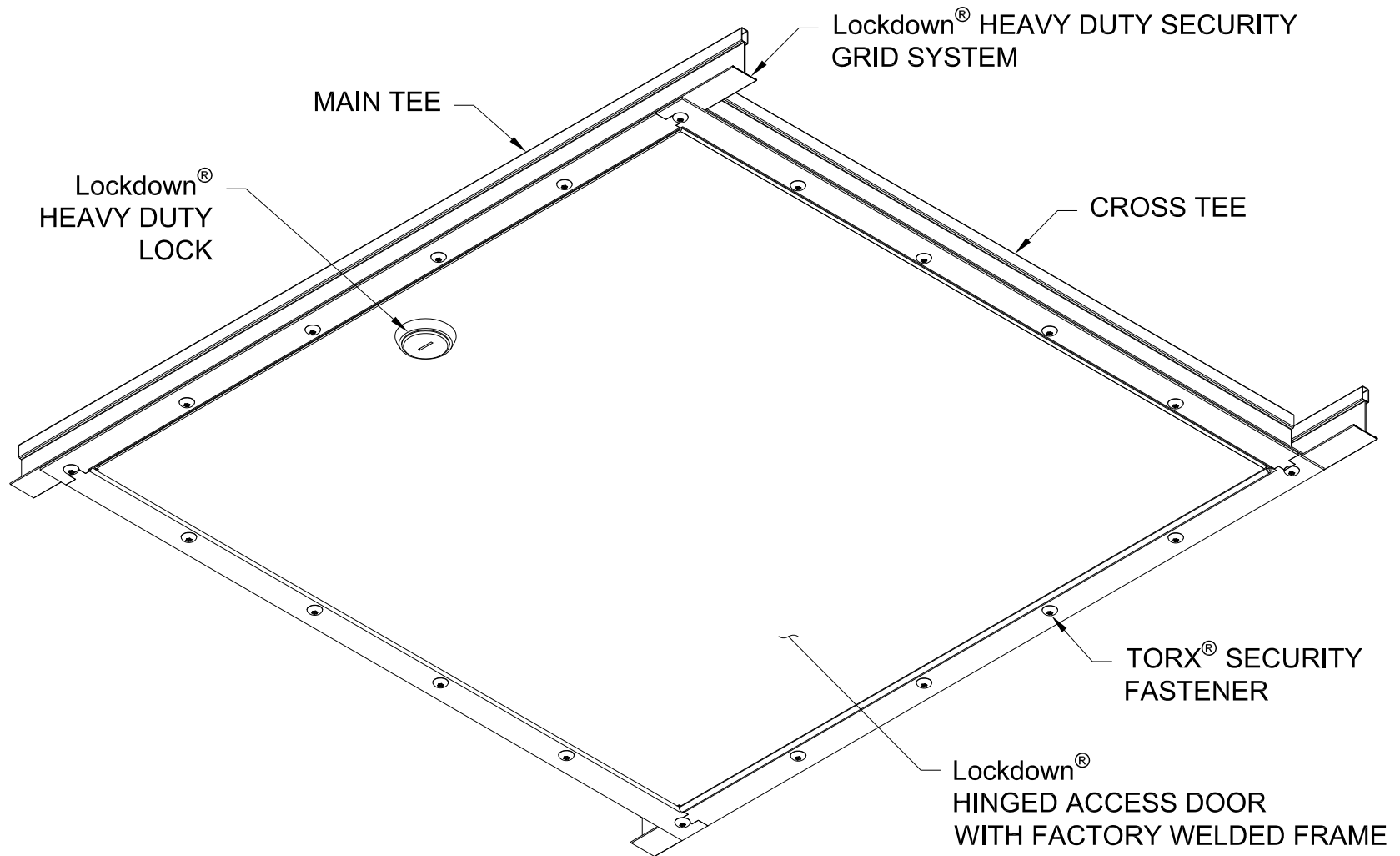

TORX® IS A REGISTERED
TRADEMARK OF CAMCAR

2' X 2' SHOWN
2' X 4' ALSO AVAILABLE

GORDON®
ARCHITECTURAL+ENGINEERED SOLUTIONS

5023 Hazel Jones Rd.
Bossier City, LA 71111
800.747.8954
GORDON-INC.COM
sales@gordon-inc.com

**SECURITY CEILINGS
TAMPER-EVIDENT - LOCKDOWN
ACCESS DOOR ISOMETRIC**

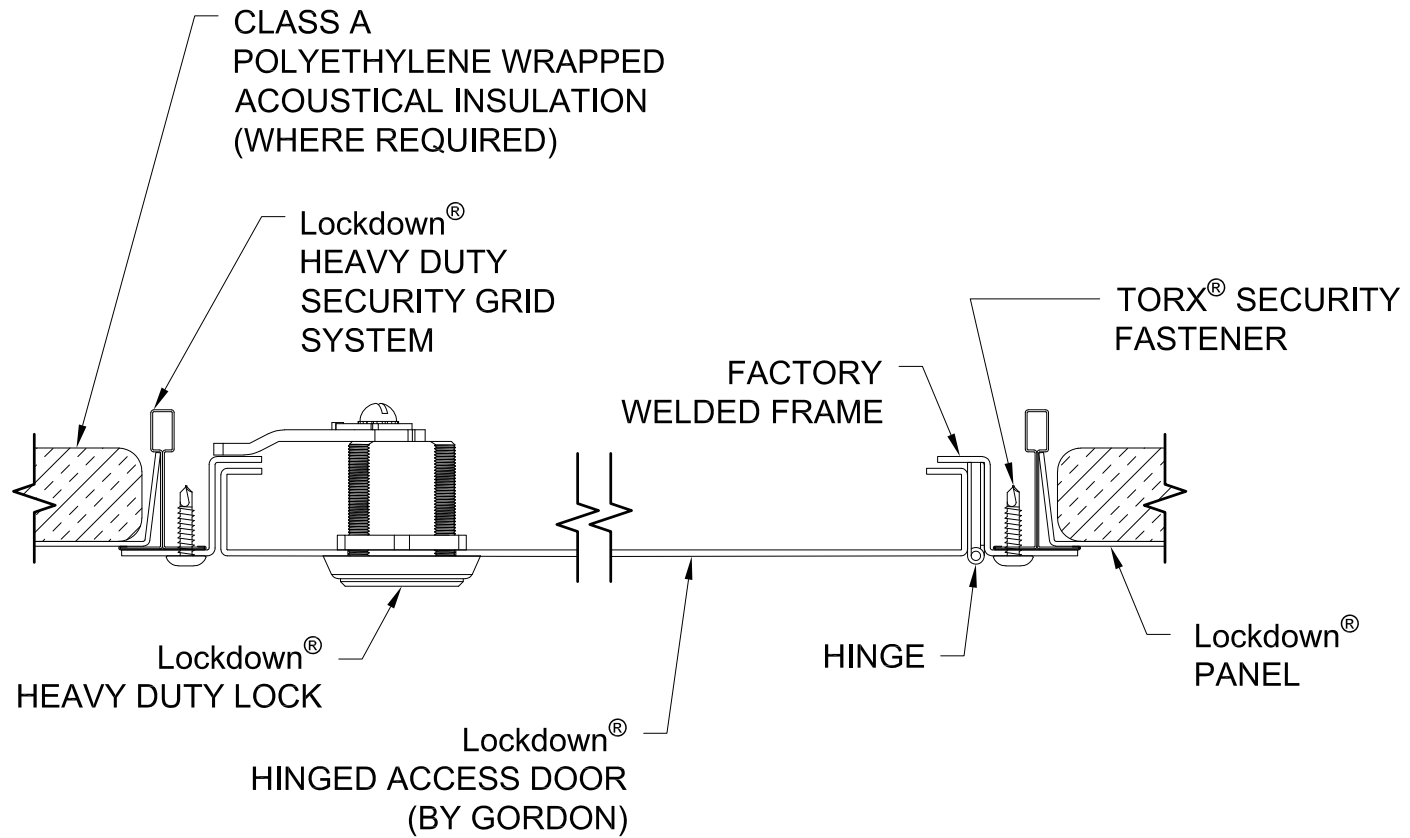

TORX® IS A REGISTERED
TRADEMARK OF CAMCAR

2' X 2' AND 2' X 4'
SIZES AVAILABLE

GORDON®
ARCHITECTURAL+ENGINEERED SOLUTIONS

5023 Hazel Jones Rd.
Bossier City, LA 71111
800.747.8954
GORDON-INC.COM
sales@gordon-inc.com

SECURITY CEILINGS
TAMPER-EVIDENT - LOCKDOWN
ACCESS DOOR SECTION

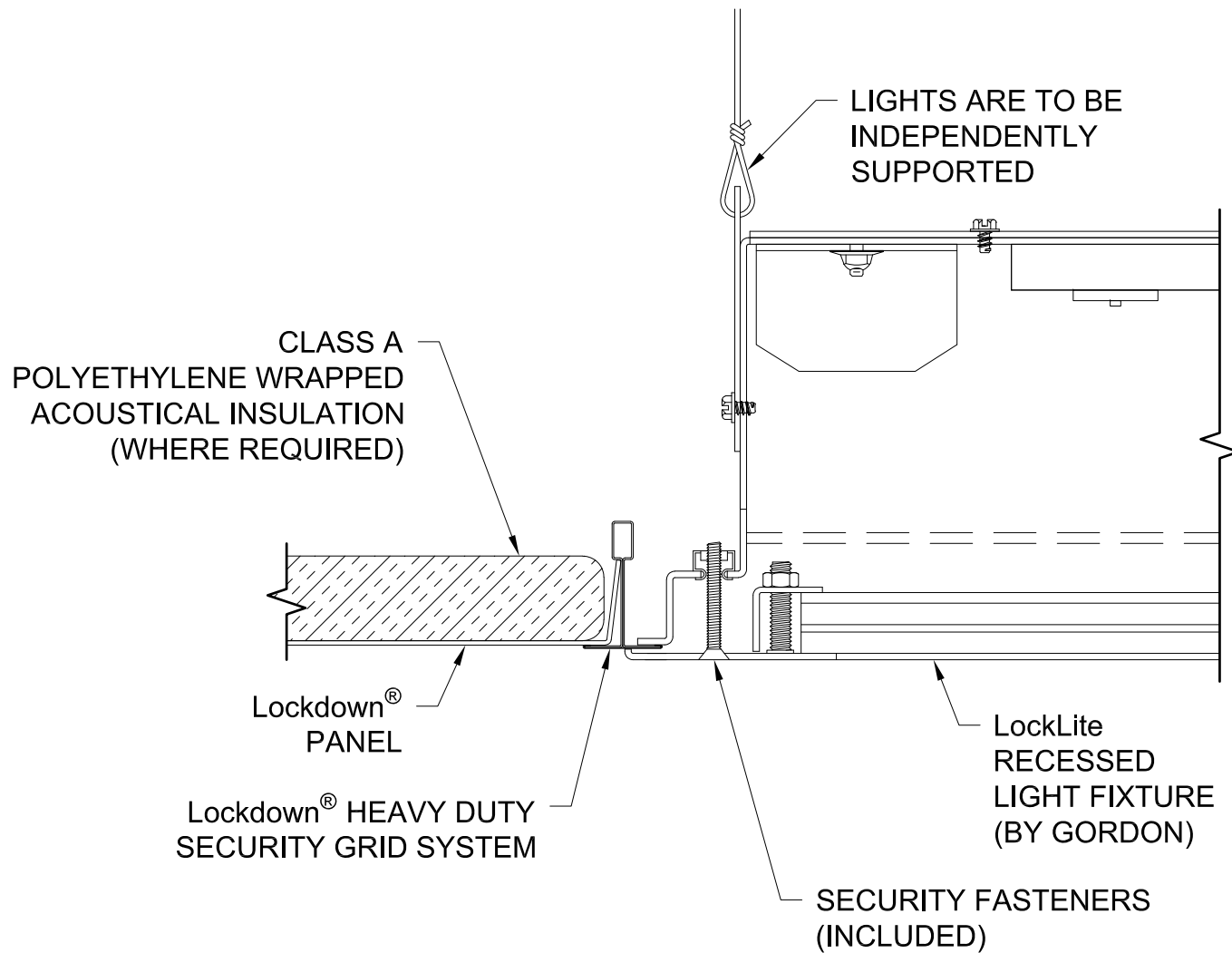

GORDON®
ARCHITECTURAL+ENGINEERED SOLUTIONS

5023 Hazel Jones Rd.
Bossier City, LA 71111
800.747.8954
GORDON-INC.COM
sales@gordon-inc.com

**SECURITY CEILINGS
TAMPER-EVIDENT - LOCKDOWN
RECESSED LIGHT SECTION**

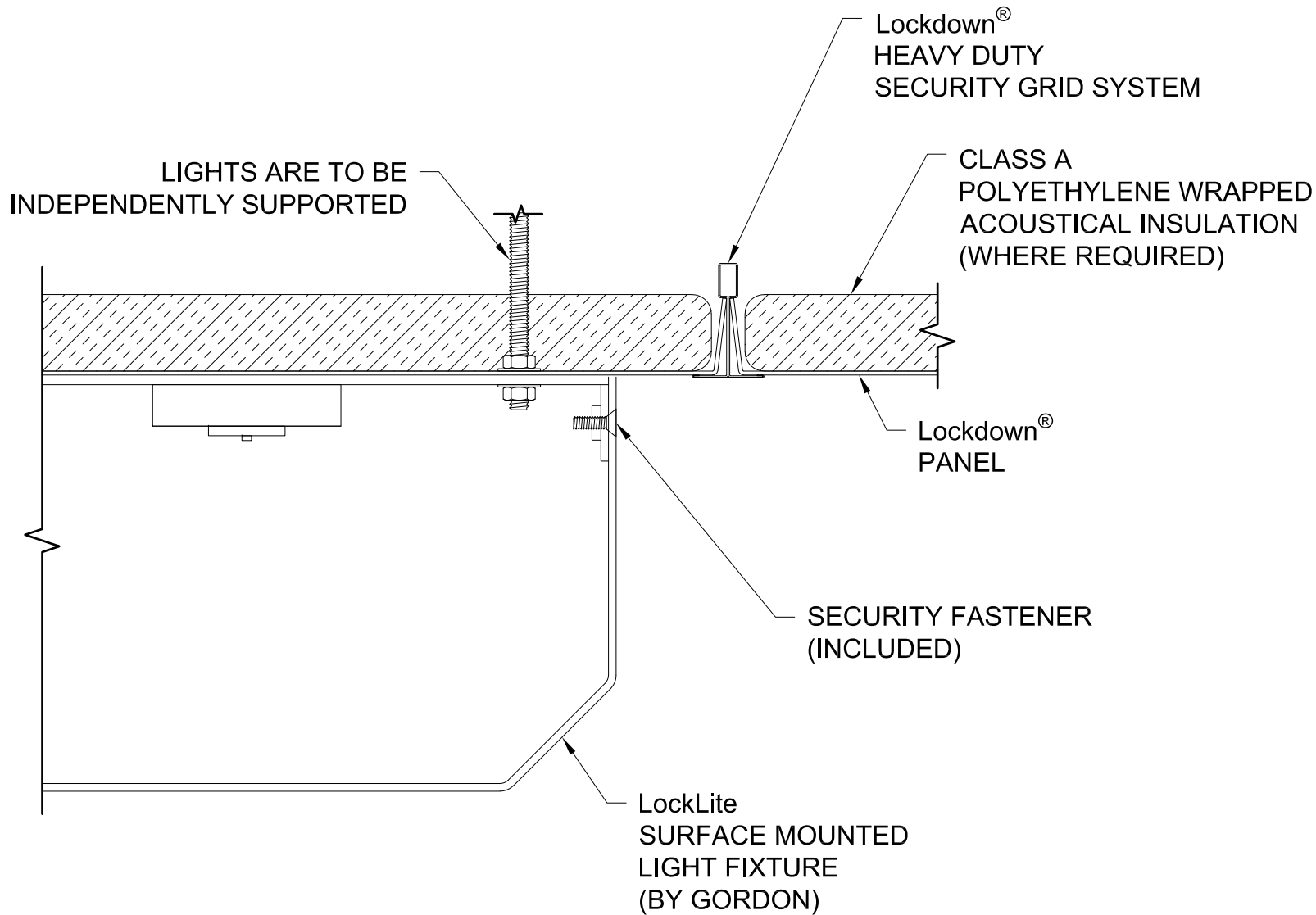

GORDON®
ARCHITECTURAL+ENGINEERED SOLUTIONS

5023 Hazel Jones Rd.
Bossier City, LA 71111
800.747.8954
GORDON-INC.COM
sales@gordon-inc.com

**SECURITY CEILINGS
TAMPER-EVIDENT - LOCKDOWN
SURFACE LIGHT SECTION**

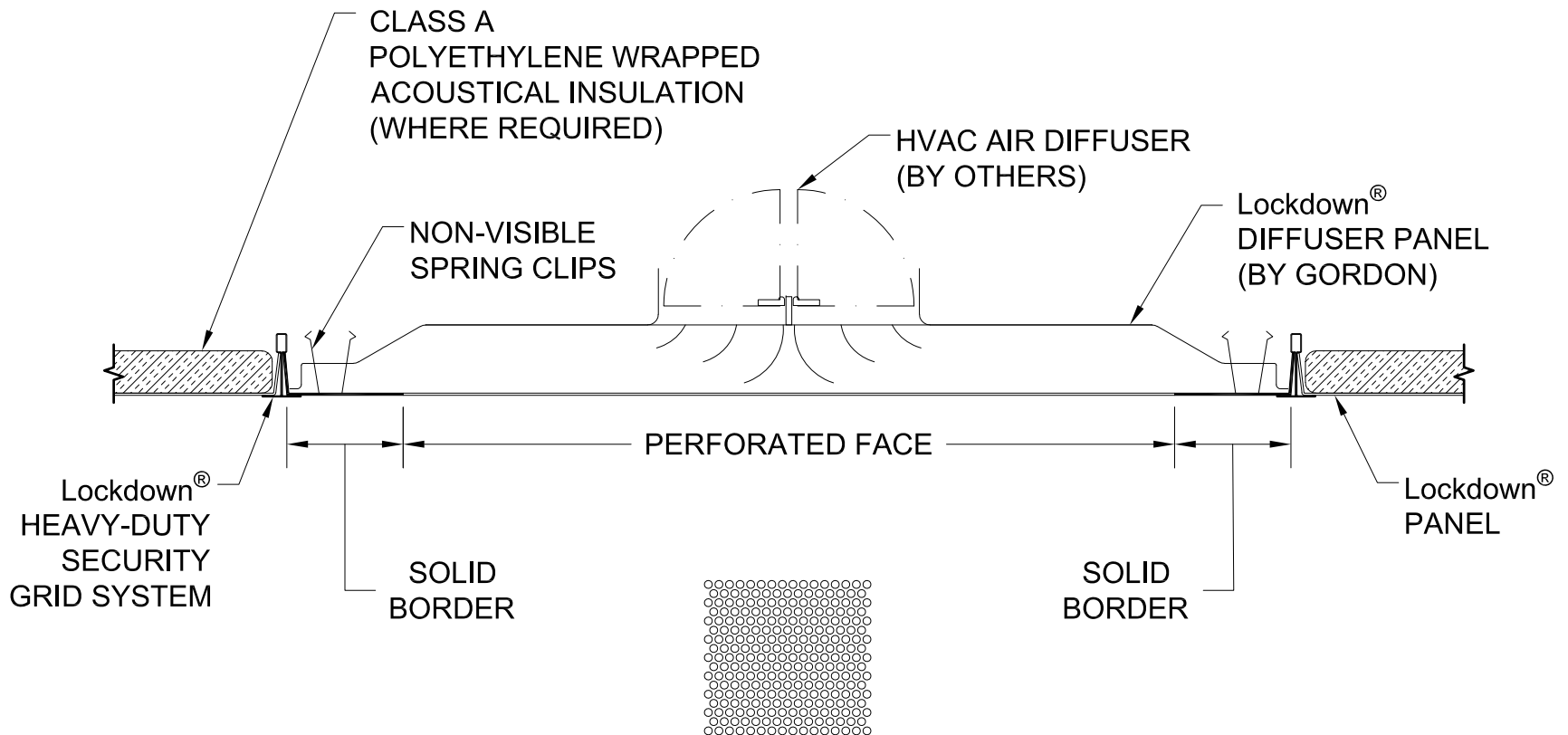

DIFFUSER PANEL PERFORATION PATTERN
3/16" HOLES ON 1/4" STAGGERED CENTERS
50% OPEN AREA

OTHER PERFORATION PATTERNS ARE AVAILABLE
 (CONTACT FACTORY)

GORDON®
 ARCHITECTURAL+ENGINEERED SOLUTIONS

5023 Hazel Jones Rd.
 Bossier City, LA 71111
 800.747.8954
 GORDON-INC.COM
 sales@gordon-inc.com

SECURITY CEILINGS
 TAMPER-EVIDENT - LOCKDOWN
 HVAC DIFFUSER SECTION