

DETAIL N

DETAIL M

GORDON®
ARCHITECTURAL+ENGINEERED SOLUTIONS

5023 Hazel Jones Rd.
Bossier City, LA 71111
800.747.8954
GORDON-INC.COM
sales@gordon-inc.com

WALLS / CLADDINGS
WP MR - REVEAL JOINT
ISOMETRIC VIEW

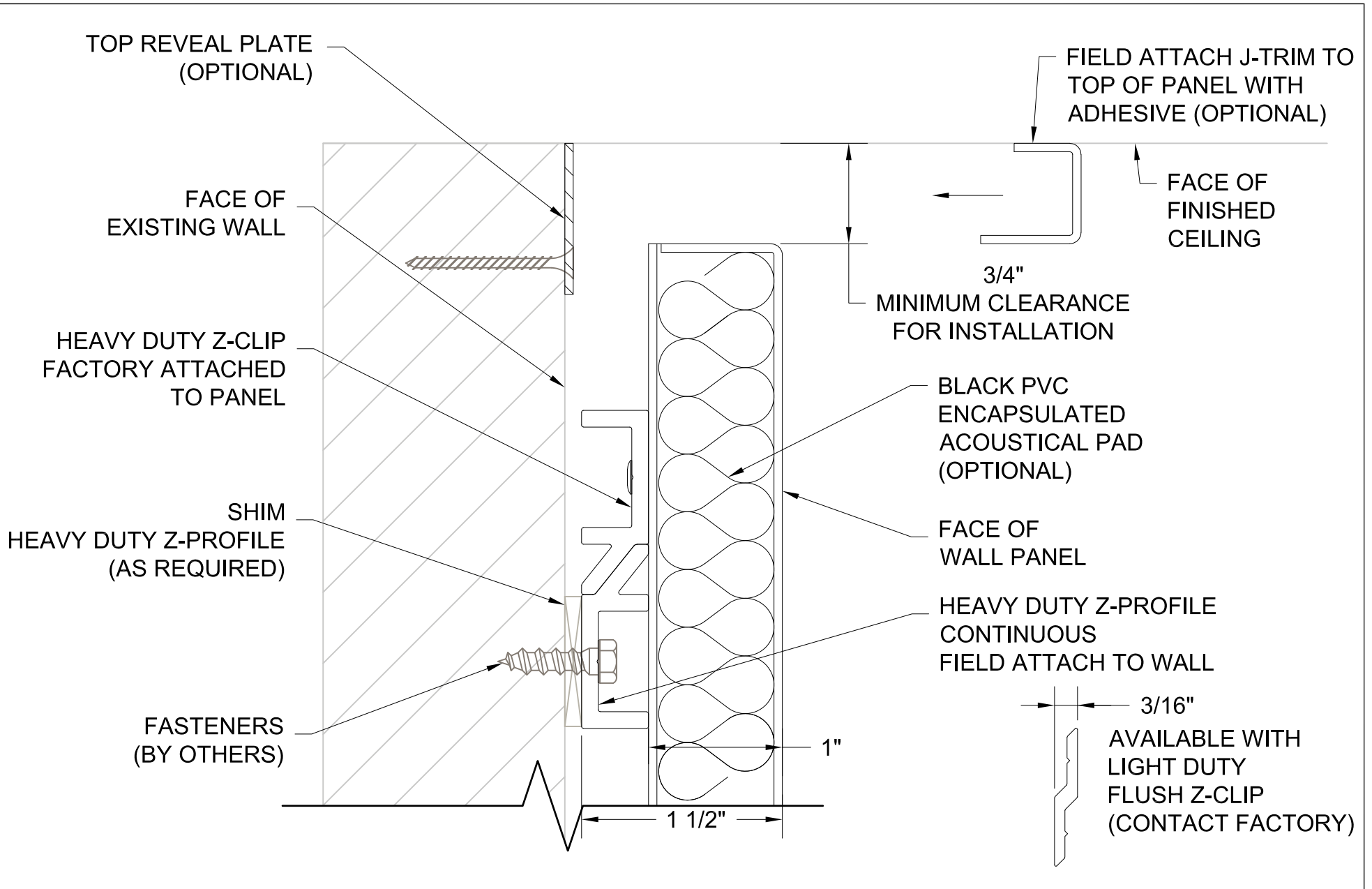

GORDON
ARCHITECTURAL+ENGINEERED SOLUTIONS

5023 Hazel Jones Rd.
Bossier City, LA 71111
800.747.8954
GORDON-INC.COM
sales@gordon-inc.com

WALLS / CLADDINGS
WP MR - REVEAL JOINT
TOP - SECTION A

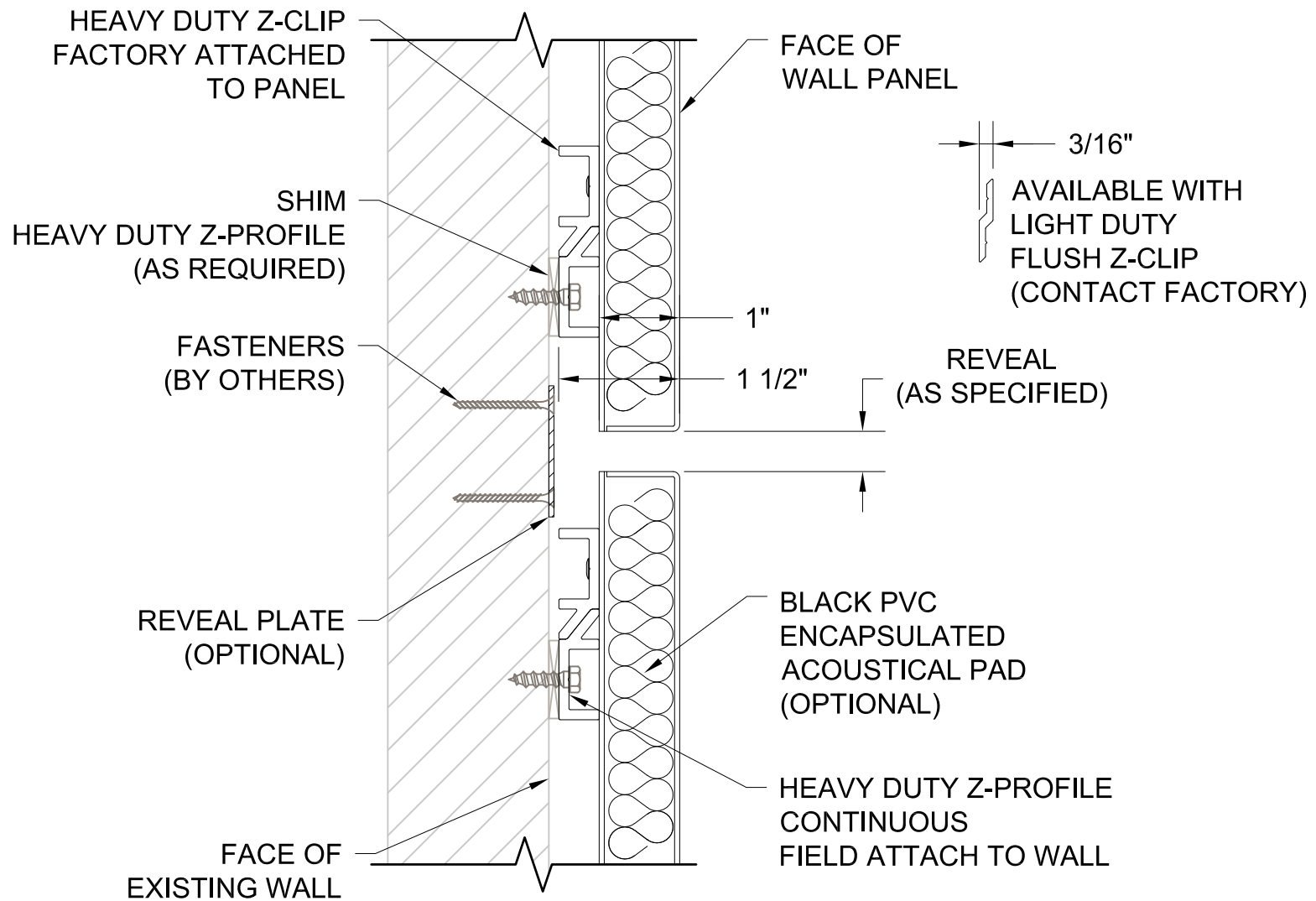

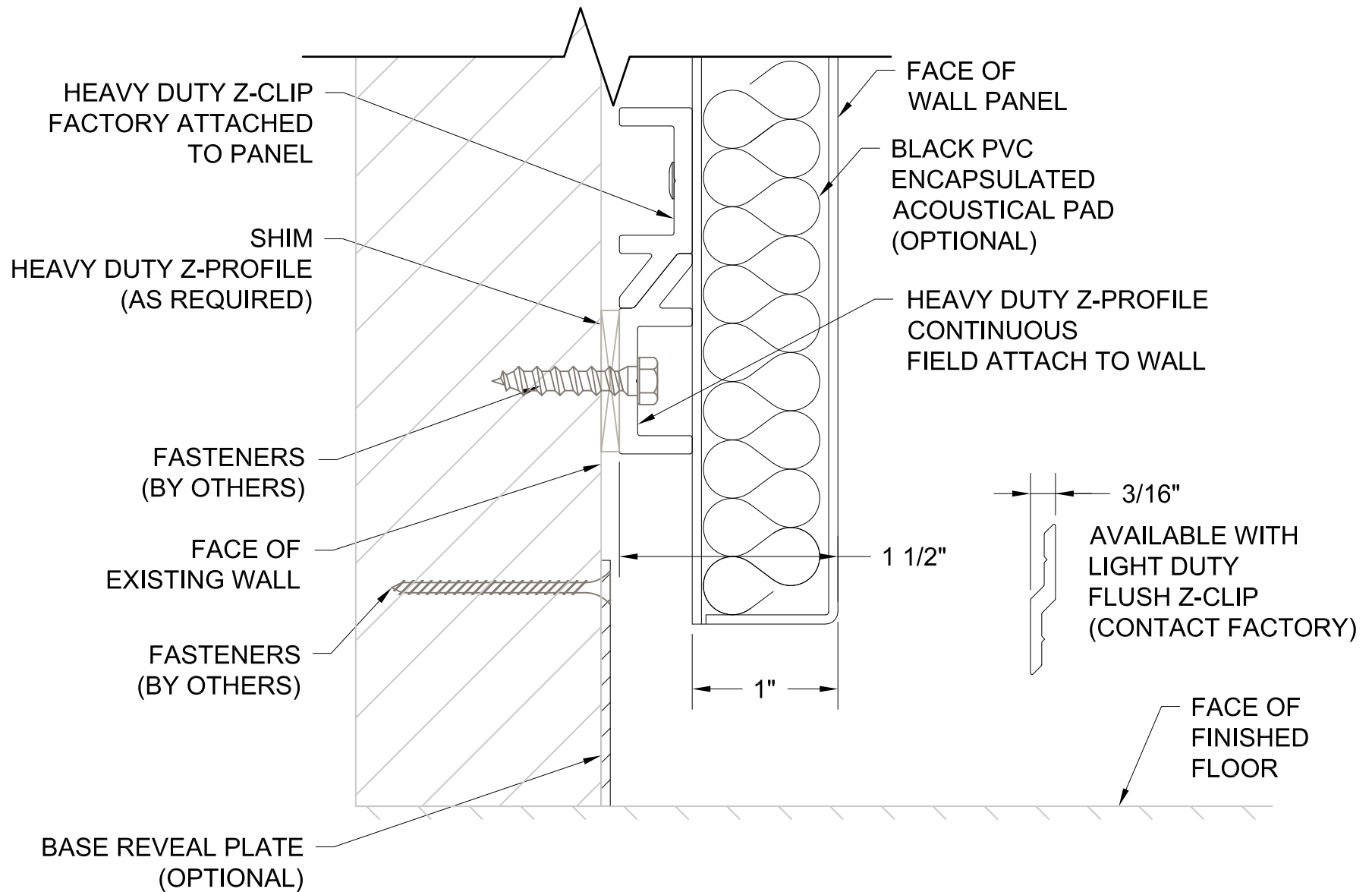

GORDON
ARCHITECTURAL+ENGINEERED SOLUTIONS

5023 Hazel Jones Rd.
Bossier City, LA 71111
800.747.8954
GORDON-INC.COM
sales@gordon-inc.com

WALLS / CLADDINGS
WP MR - REVEAL JOINT
BASE - SECTION C

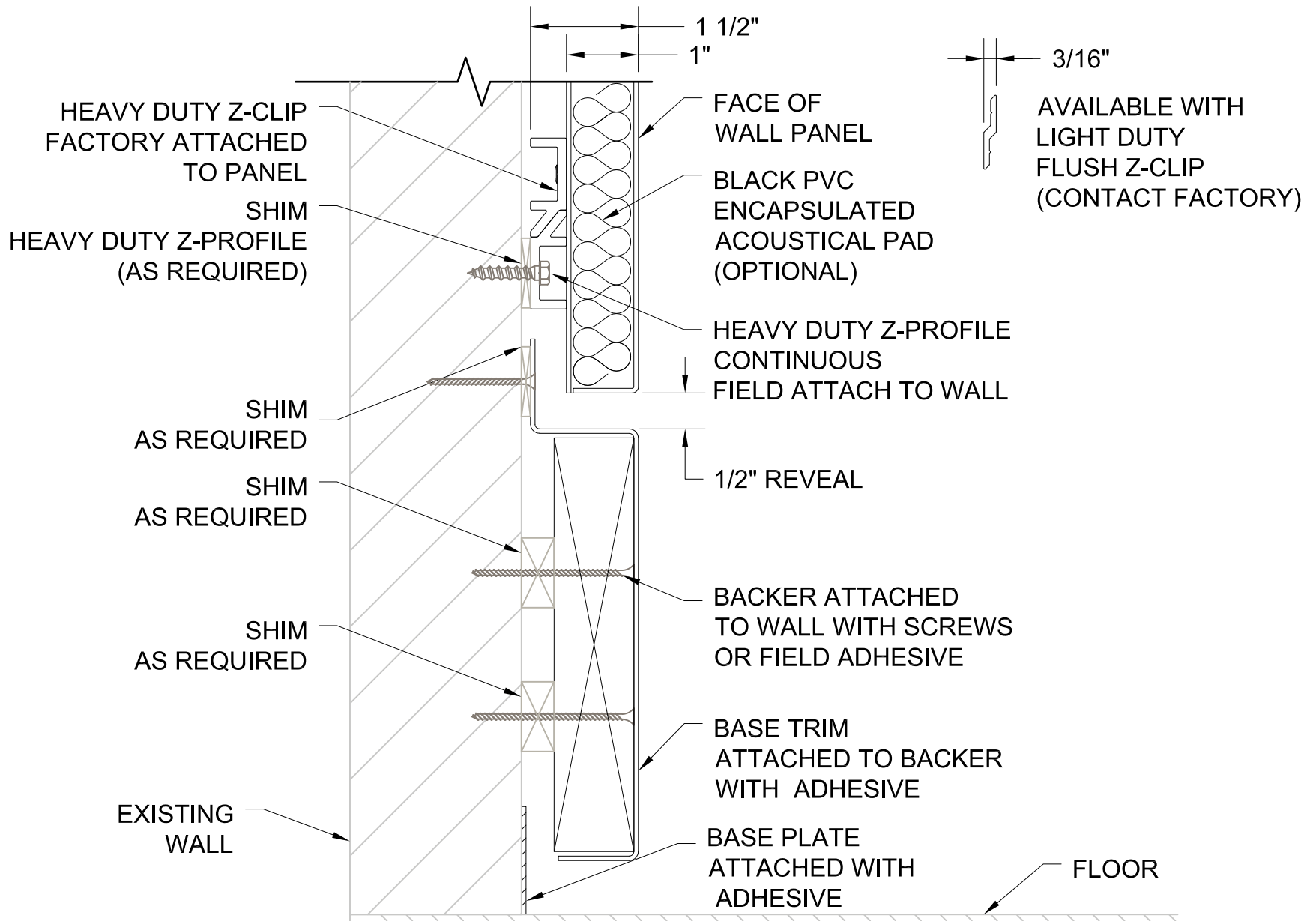

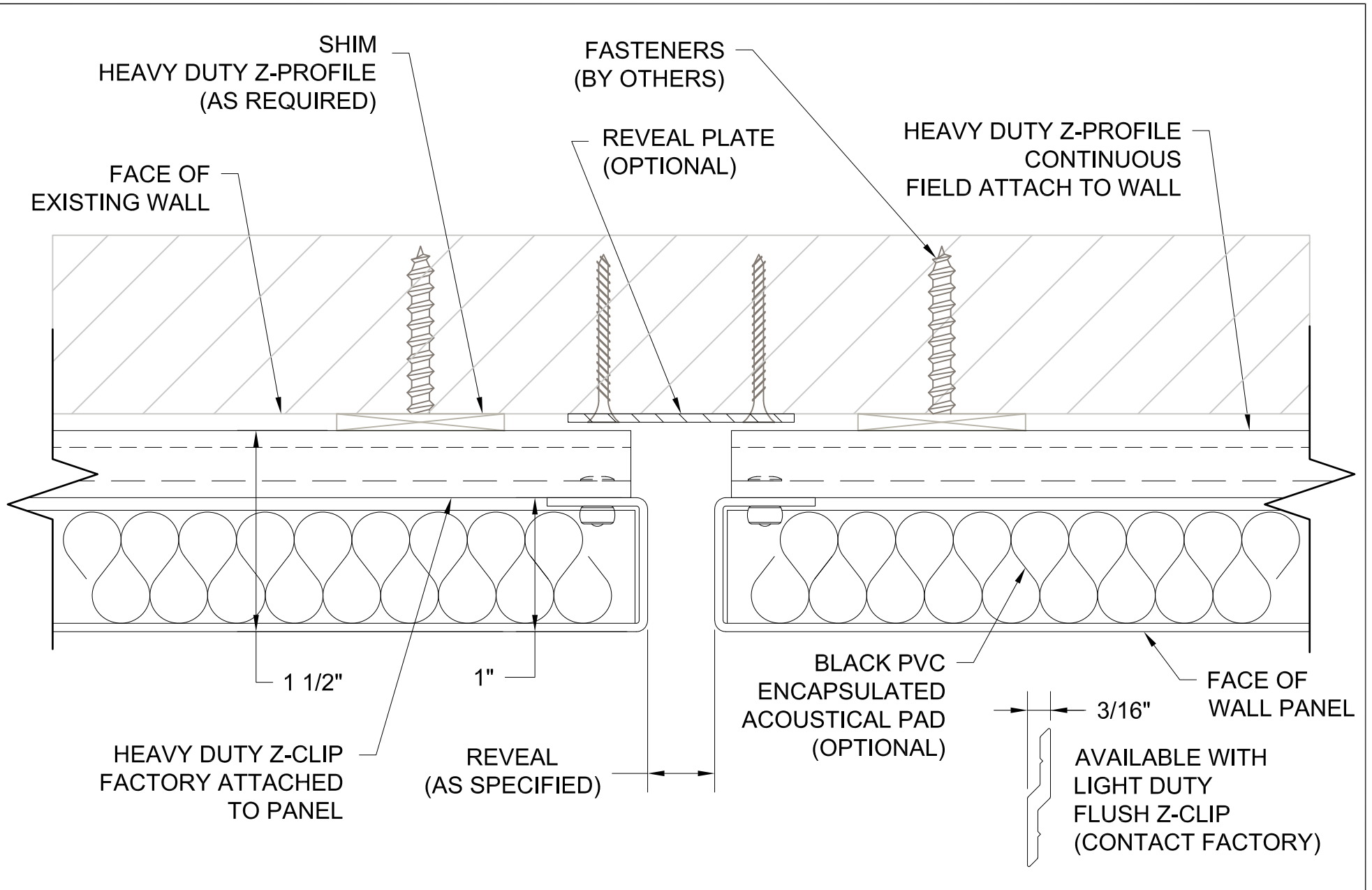

GORDON[®]
ARCHITECTURAL+ENGINEERED SOLUTIONS

5023 Hazel Jones Rd.
Bossier City, LA 71111
800.747.8954
GORDON-INC.COM
sales@gordon-inc.com

WALLS / CLADDINGS
WP MR - REVEAL JOINT
VERTICAL JOINT - SECTION D

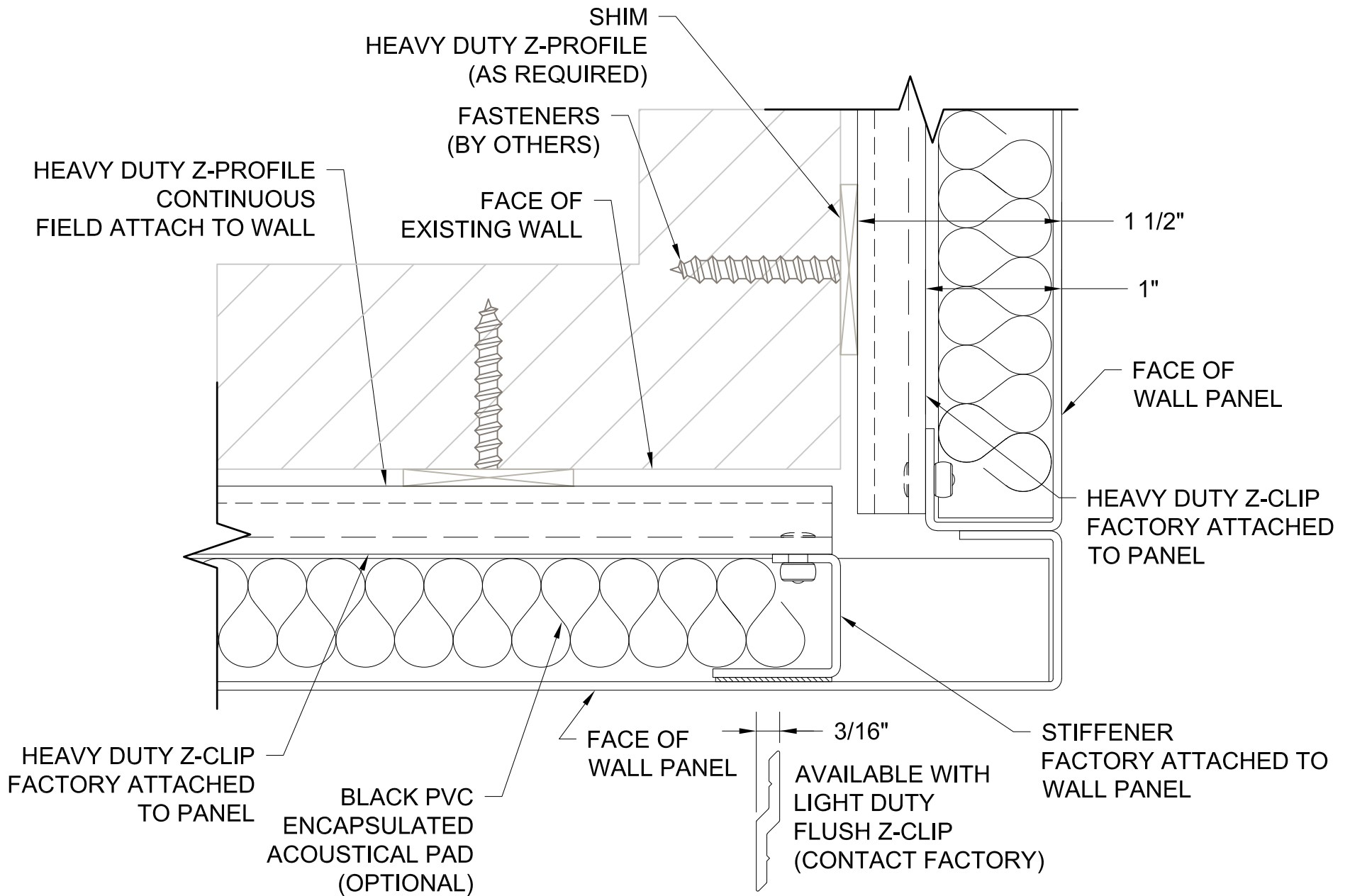

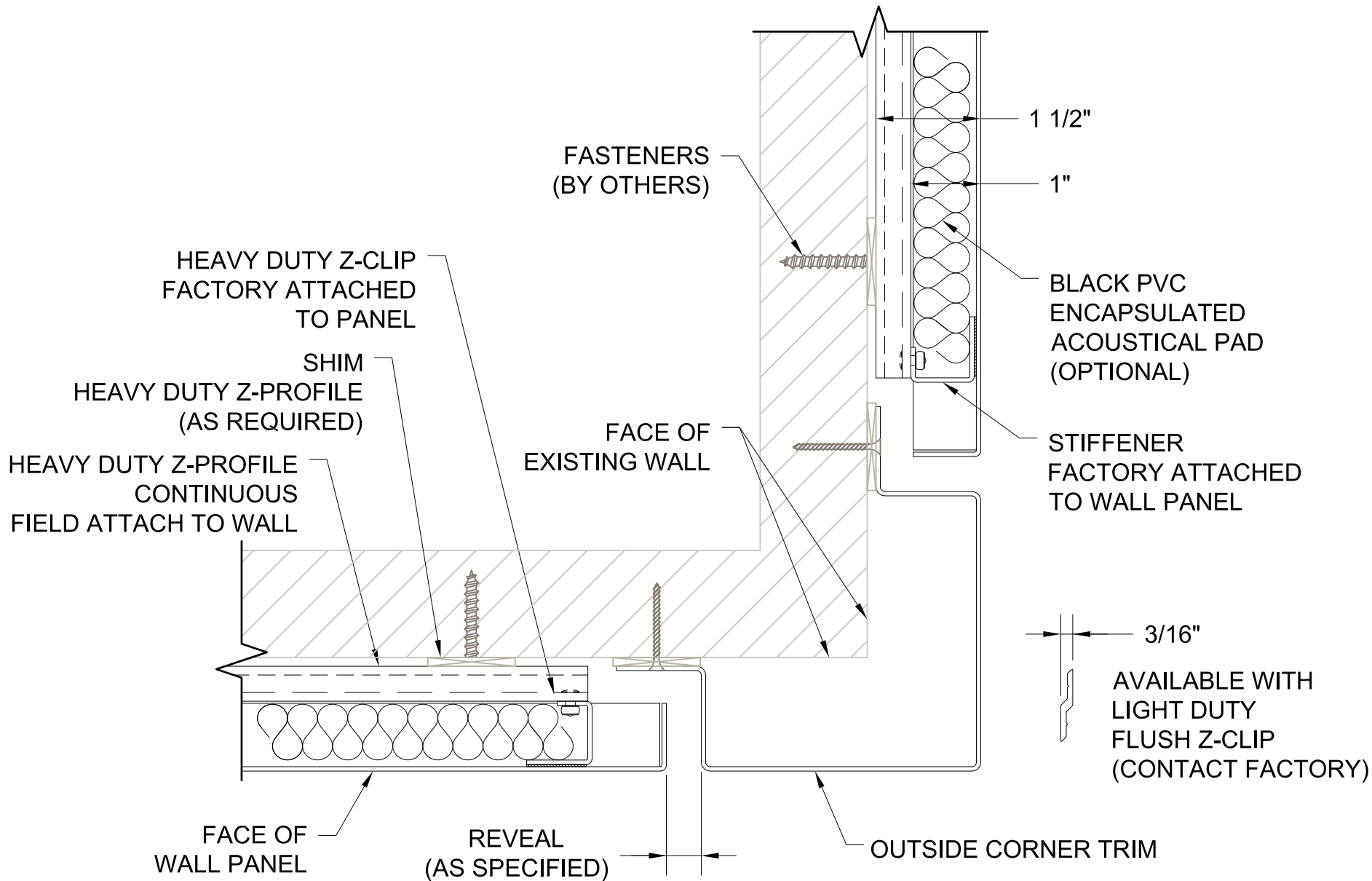

GORDON
ARCHITECTURAL+ENGINEERED SOLUTIONS

5023 Hazel Jones Rd.
Bossier City, LA 71111
800.747.8954
GORDON-INC.COM
sales@gordon-inc.com

WALLS / CLADDINGS
WP MR - REVEAL JOINT
OUTSIDE CORNER - SECTION E1

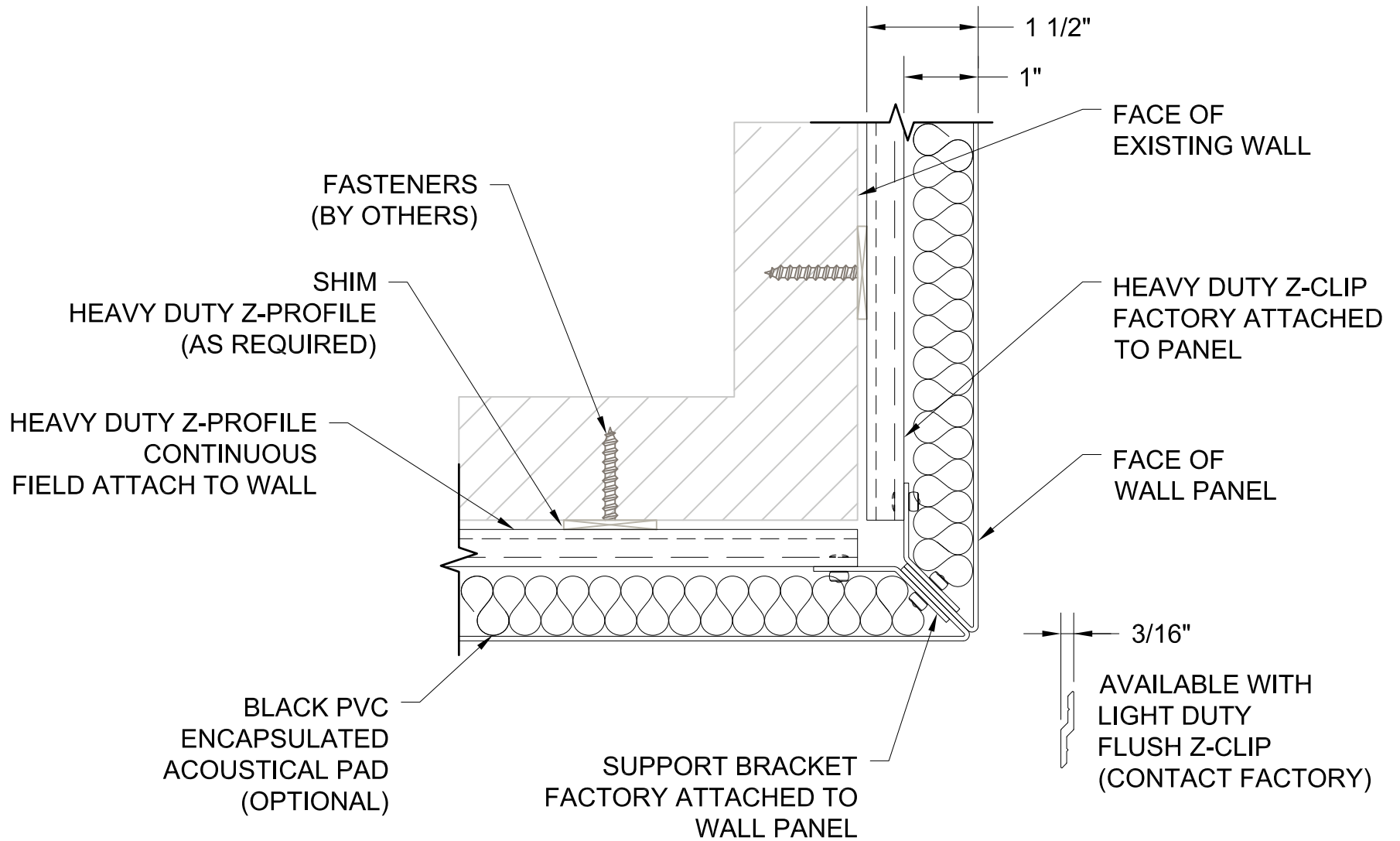

GORDON®
ARCHITECTURAL+ENGINEERED SOLUTIONS

5023 Hazel Jones Rd.
Bossier City, LA 71111
800.747.8954
GORDON-INC.COM
sales@gordon-inc.com

WALLS / CLADDINGS
WP MR - REVEAL JOINT
OUTSIDE CORNER - SECTION E2

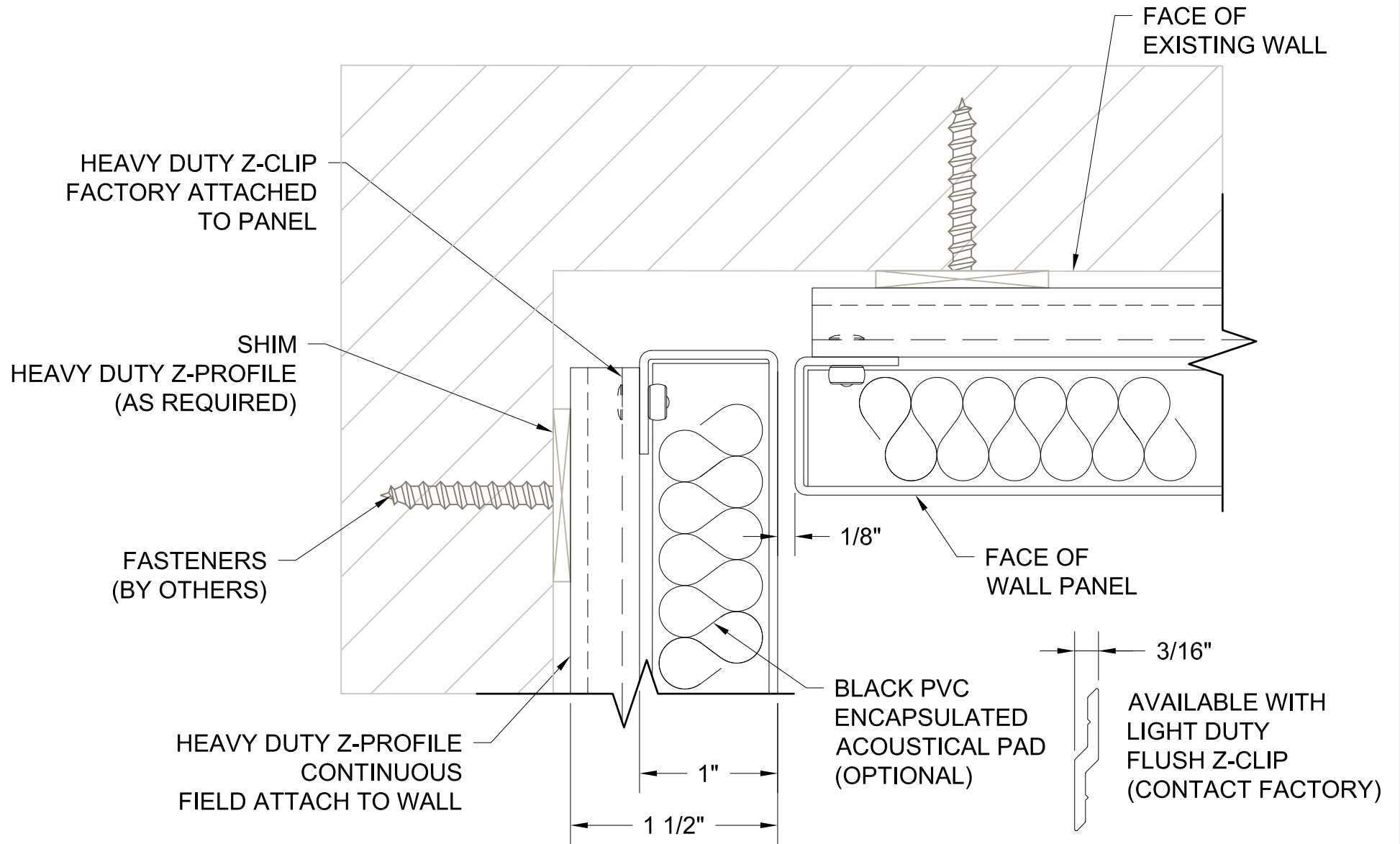

GORDON
ARCHITECTURAL+ENGINEERED SOLUTIONS

© 5023 Hazel Jones Rd.
Bossier City, LA 71111
800.747.8954
GORDON-INC.COM
sales@gordon-inc.com

WALLS / CLADDINGS
WP MR - REVEAL JOINT
INSIDE CORNER - SECTION F

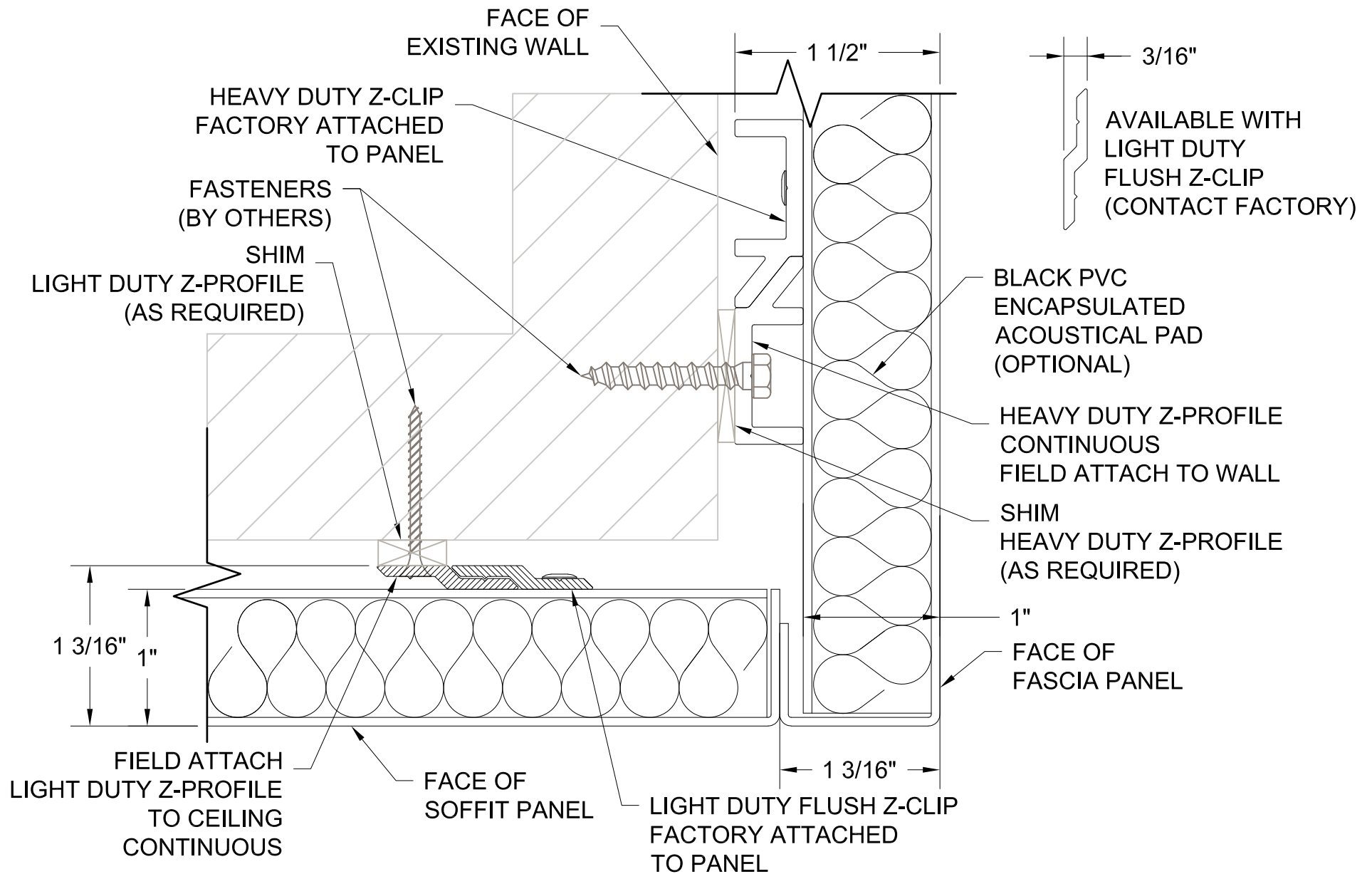

GORDON
ARCHITECTURAL+ENGINEERED SOLUTIONS

© 5023 Hazel Jones Rd.
Bossier City, LA 71111
800.747.8954
GORDON-INC.COM
sales@gordon-inc.com

WALLS / CLADDINGS
WP MR - REVEAL JOINT
SOFFIT TO FASCIA - SECTION G

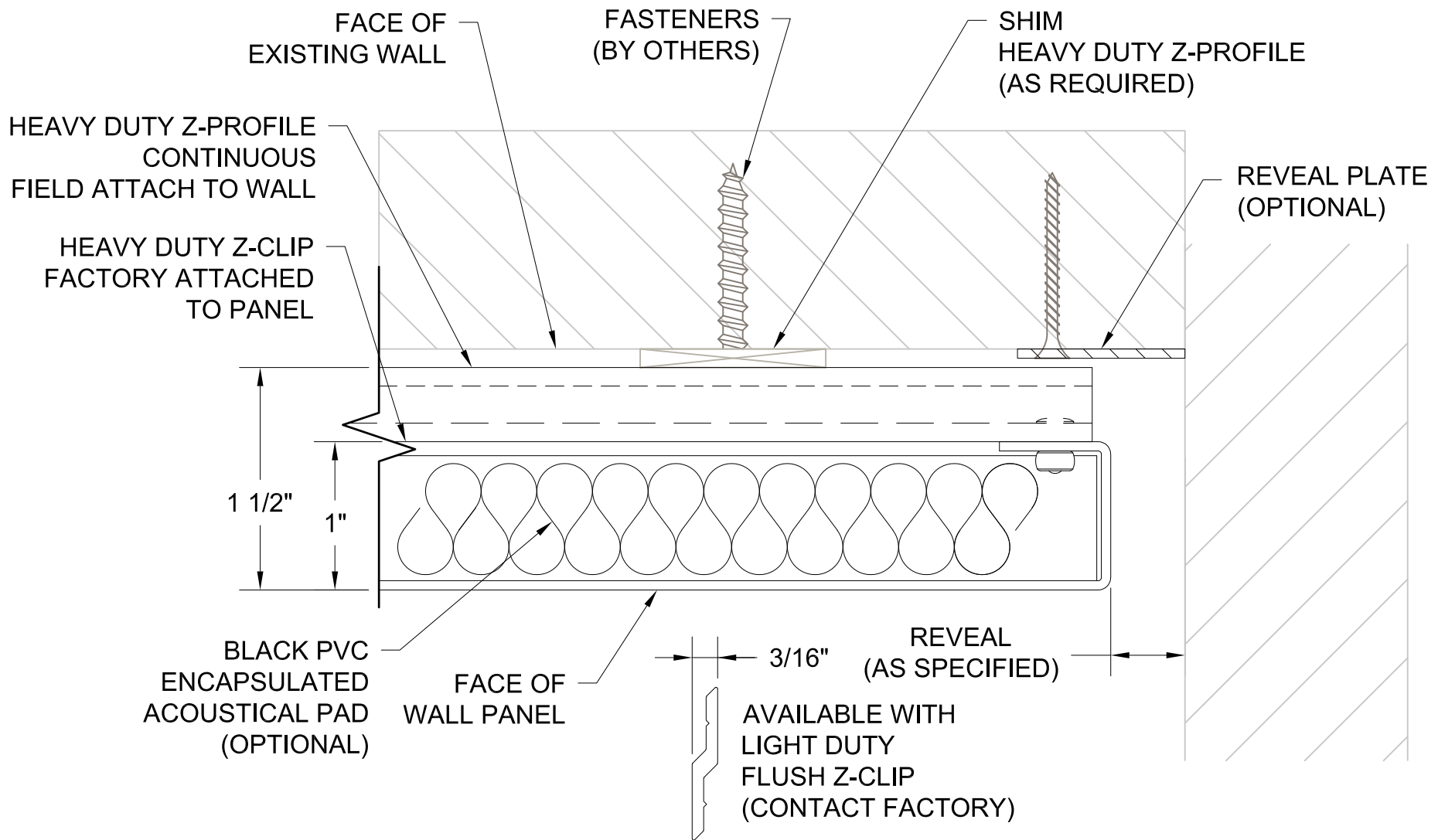

GORDON
ARCHITECTURAL+ENGINEERED SOLUTIONS

5023 Hazel Jones Rd.
Bossier City, LA 71111
800.747.8954
GORDON-INC.COM
sales@gordon-inc.com

WALLS / CLADDINGS
WP MR - REVEAL JOINT
END WALL - SECTION H

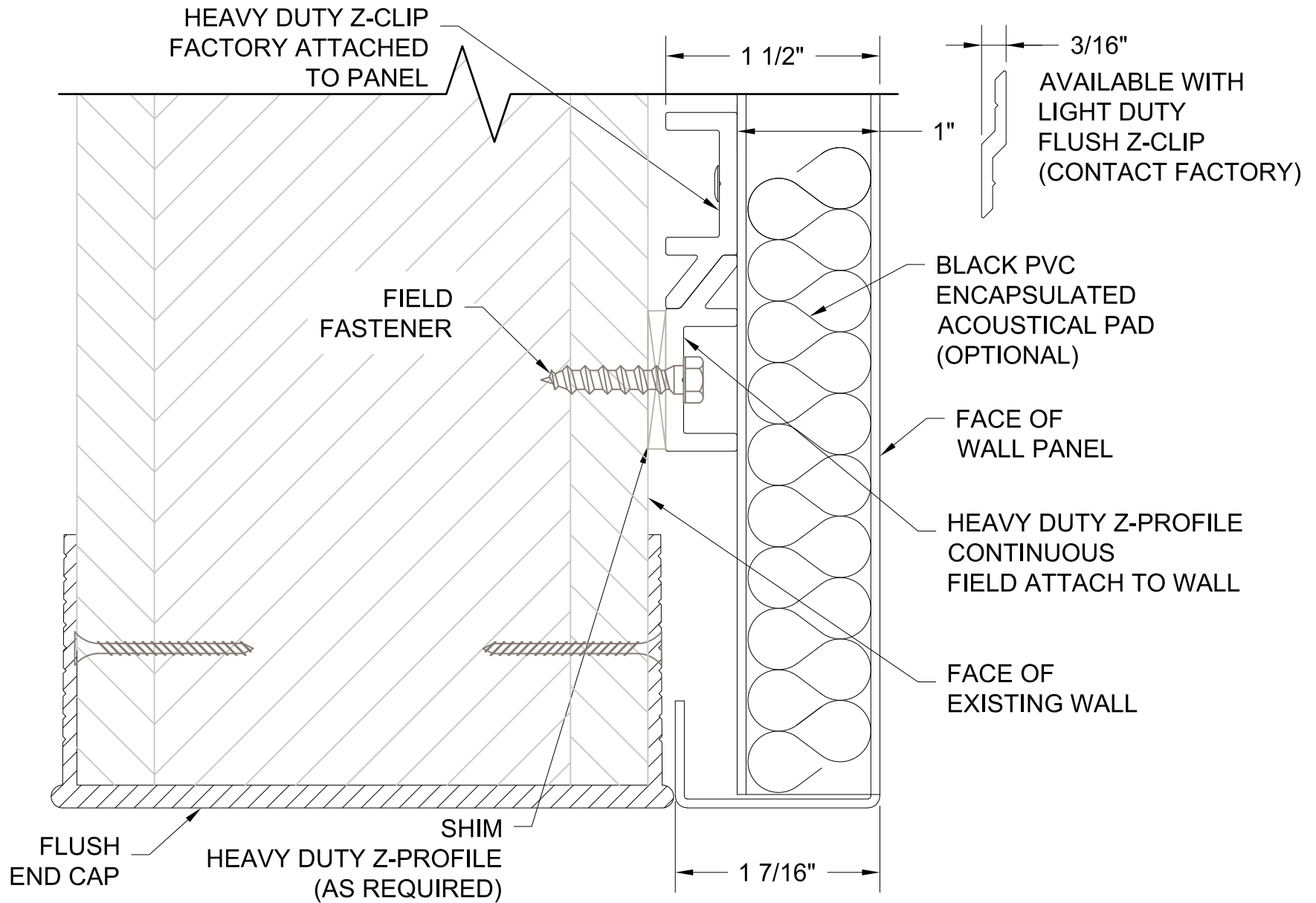

GORDON
ARCHITECTURAL+ENGINEERED SOLUTIONS

5023 Hazel Jones Rd.
Bossier City, LA 71111
800.747.8954
GORDON-INC.COM
sales@gordon-inc.com

WALLS / CLADDINGS
WP MR - REVEAL JOINT
ABOVE DOOR - SECTION J

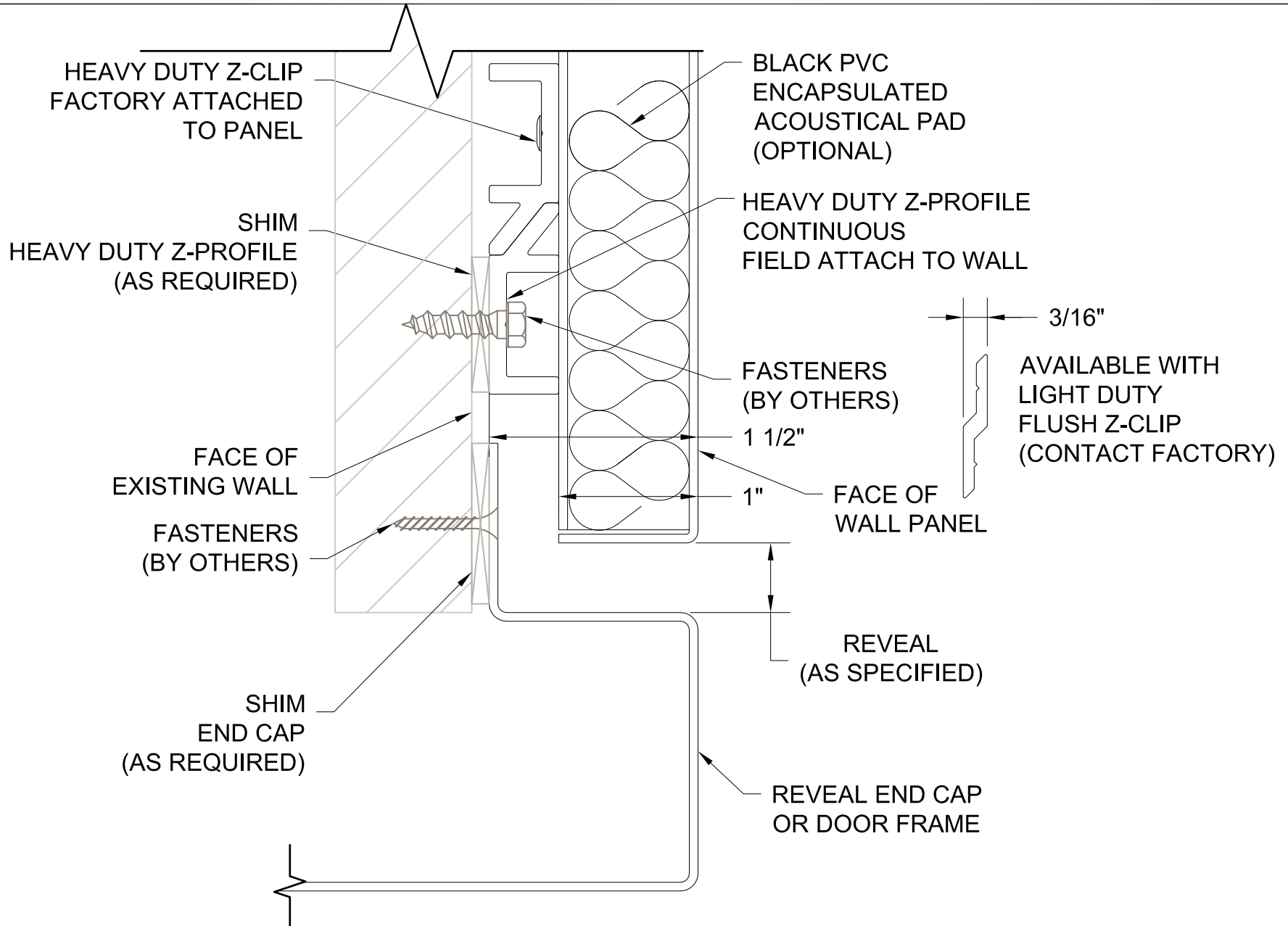

GORDON
ARCHITECTURAL+ENGINEERED SOLUTIONS

5023 Hazel Jones Rd.
Bossier City, LA 71111
800.747.8954
GORDON-INC.COM
sales@gordon-inc.com

WALLS / CLADDINGS
WP MR - REVEAL JOINT
ABOVE DOOR - SECTION J1

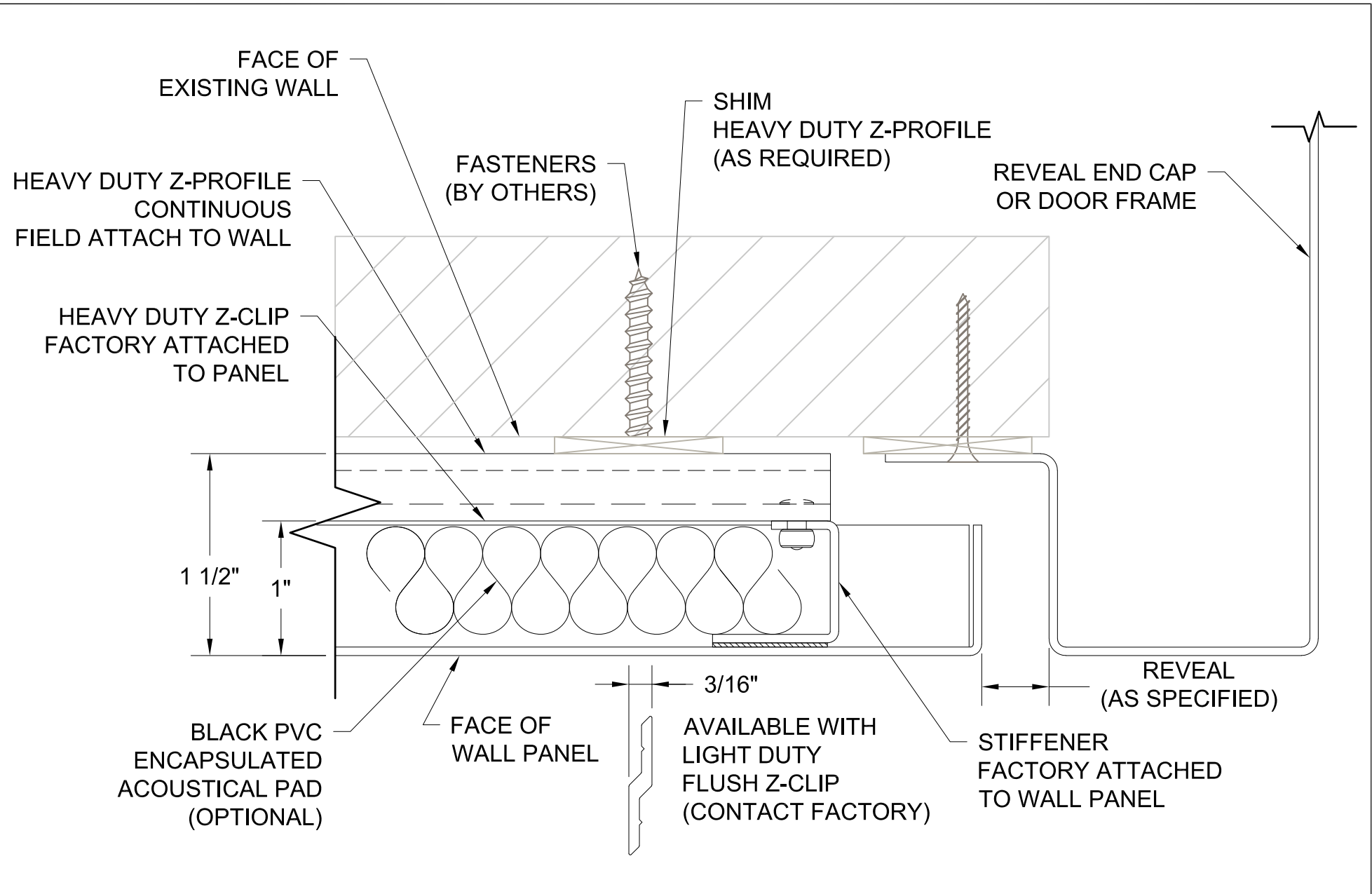

GORDON®
ARCHITECTURAL+ENGINEERED SOLUTIONS

5023 Hazel Jones Rd.
Bossier City, LA 71111
800.747.8954
GORDON-INC.COM
sales@gordon-inc.com

WALLS / CLADDINGS
WP MR - REVEAL JOINT
END WALL - SECTION K

